

THE PROPERTY OF THE DRAWING IS ESTABLISHED BY LAW. IT IS FORBIDDEN TO PRODUCE OR SHOW IT TO THIRD PARTY, WITHOUT A WRITTEN AGREEMENT.

Item	Name	Q.ty
1	04.08.003	1
2	R.5.SCH	1
3	V.TCE5x18	1

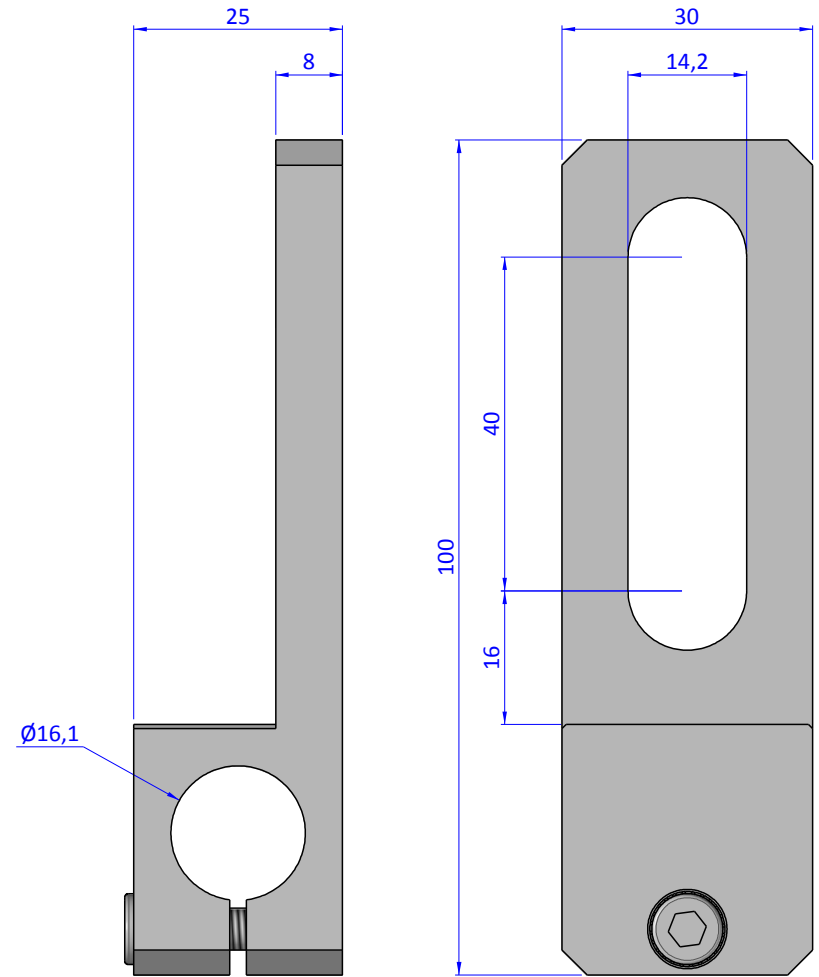
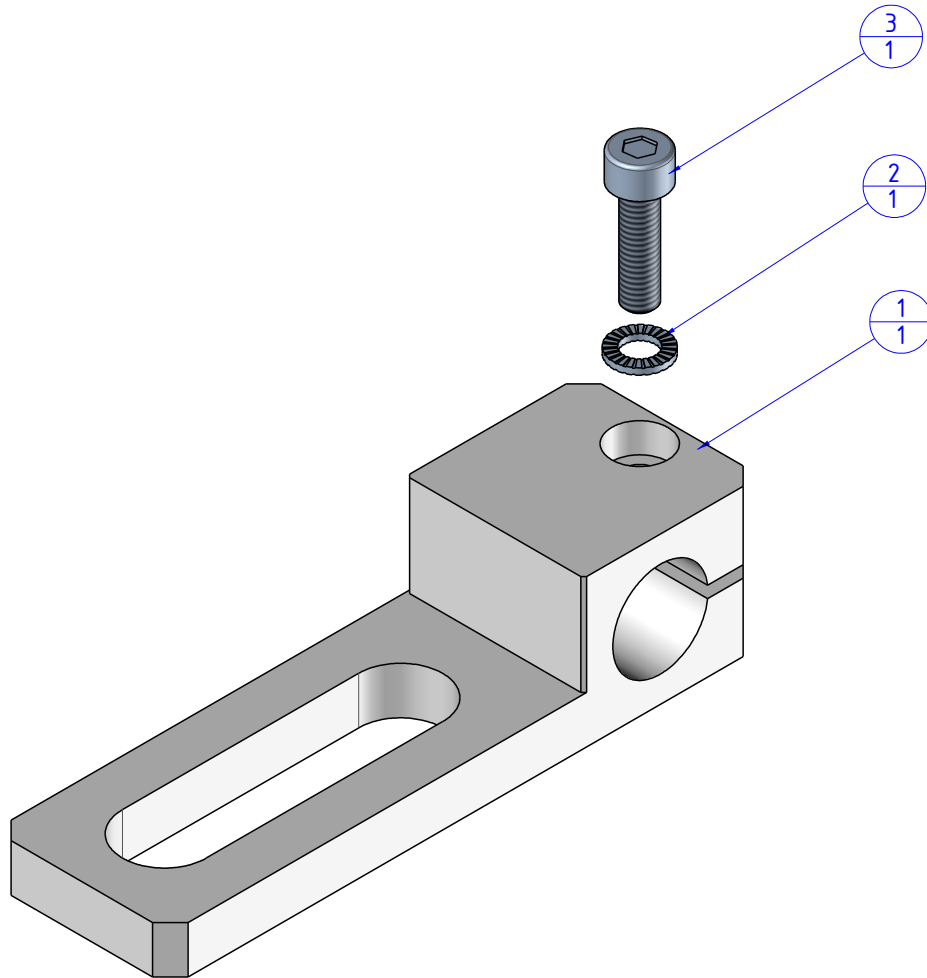

Format A3

UNI 936-76

		DESIGNED FROM		REVIEW
		FPS Automation		A
GENERAL TOLERANCE		DATE	WEIGHT	
UNI - ISO 2768		24/07/2019	0,075kg	
CLASSE f	DESCRIPTION	CODE		
	CA.04.08.003	CA.04.08.003		